

Ravensburger 3D puzzle

Disney

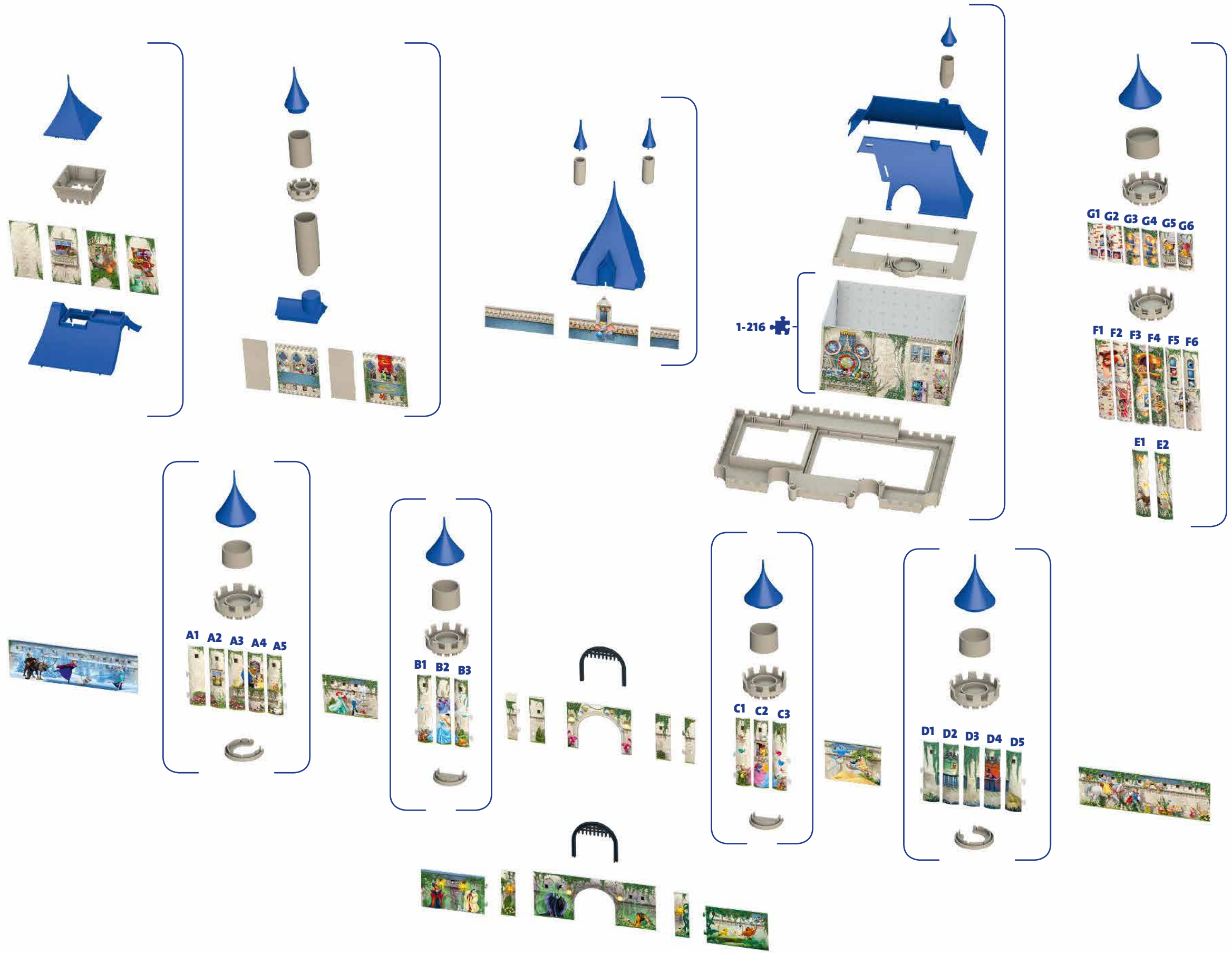

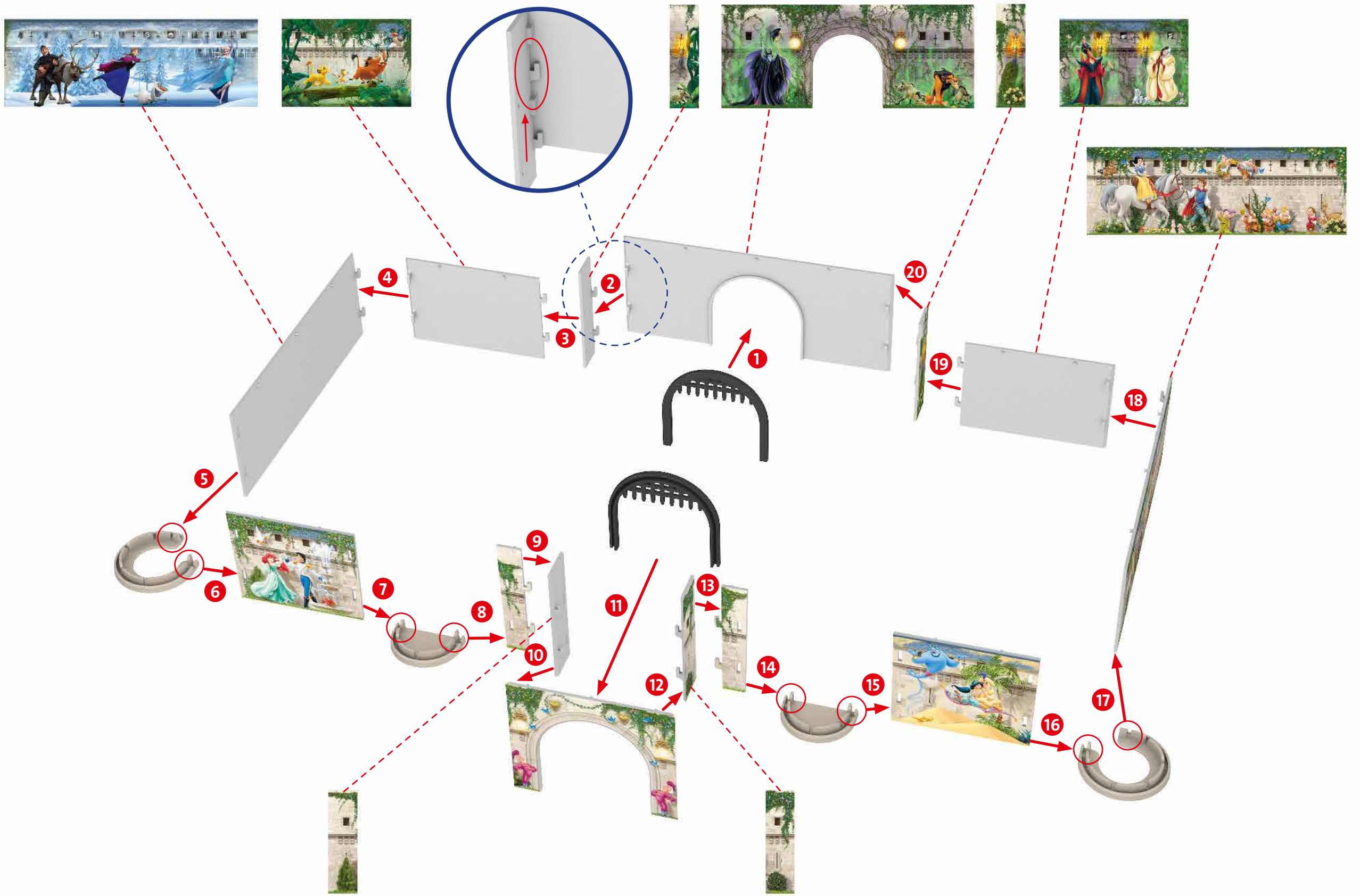



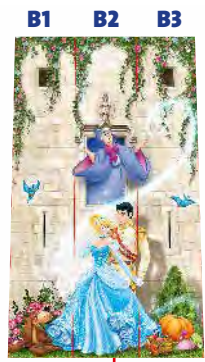

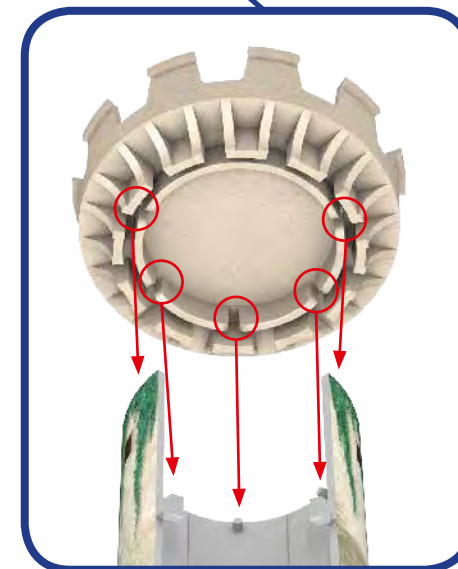
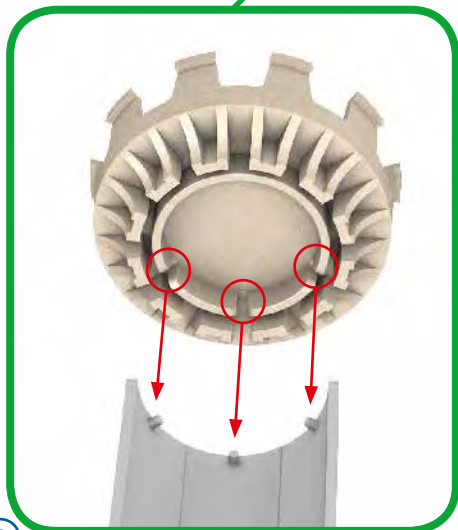
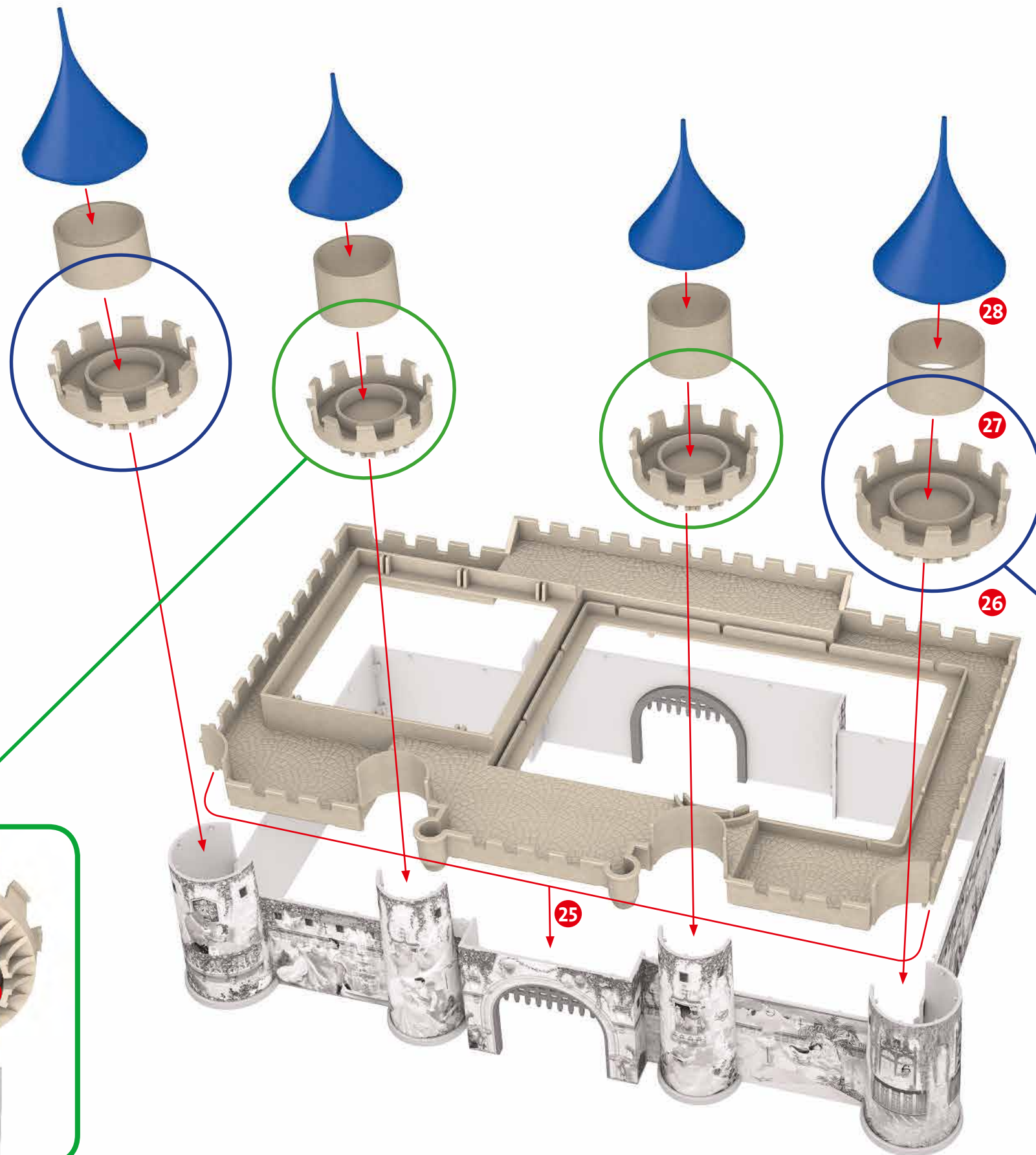

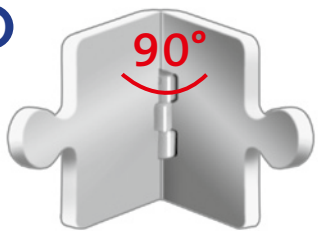
D

- Knick-Puzleteile leicht vorknicken
- Slightly pre-bend hinged puzzle pieces
- Pièces de puzzles légèrement incurvées et pliables
- Prima del montaggio, piegare leggermente i pezzi con giuntura
- Antes de empezar el montaje, doblar ligeramente las piezas con juntura
- De geknikte puzzelstukjes iets voorbuigen

**29**

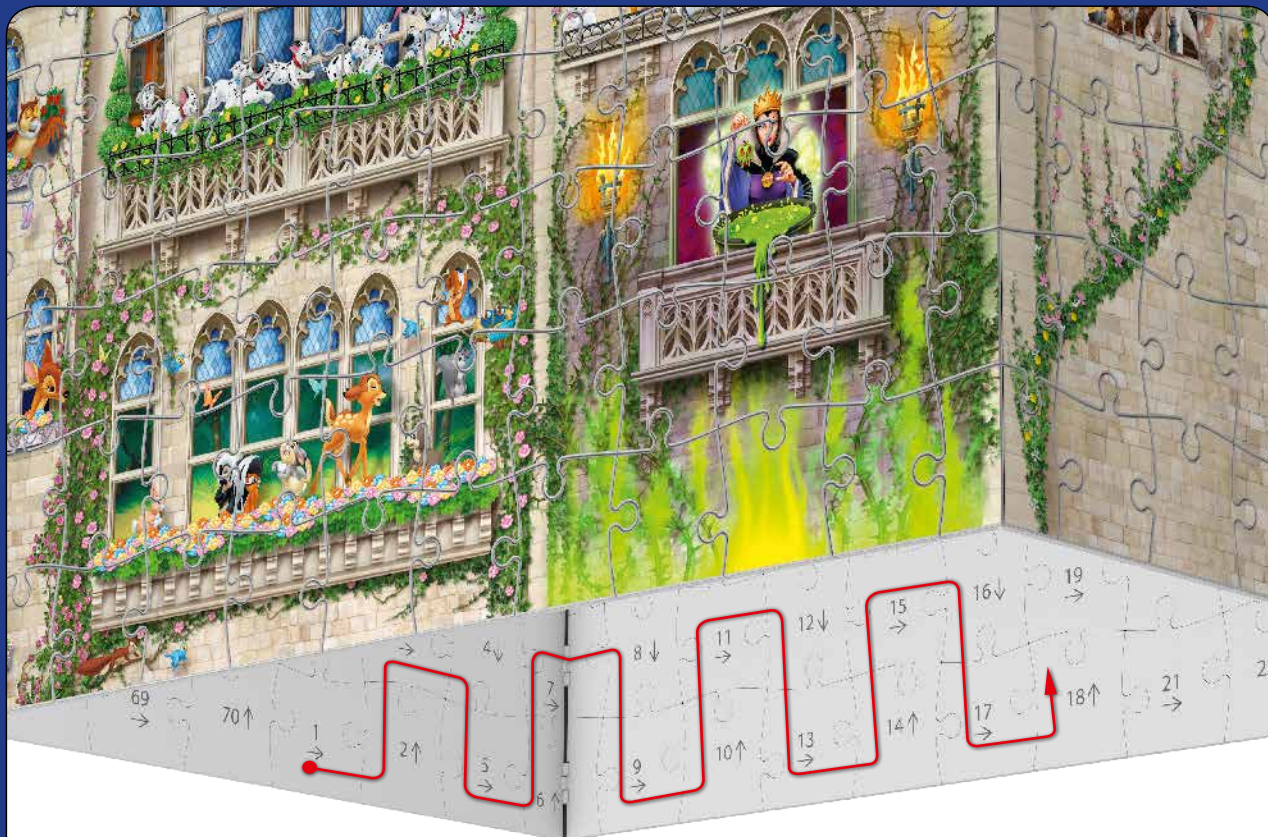
1-216
**D** **Puzzeln nach Zahlen**

Starte bei 1 und setze die Teile der Reihe nach an.

I **Componi seguendo i numeri**

Incastra un pezzo per volta, iniziando dal n° 1.

GB USA **Puzzle by numbers**

Start with piece No 1 and add the others in sequence.

NL **Puzzelen volgens getallen**

Begin bij en bring de stukjes in volgorde aan.

F **Assemble les pièces à l'aide de numéros**

Commence par le bas avec la N° 1 et assemble les suivantes dans l'ordre.

E **Montar el puzzle siguiendo los números**

Comienza con la pieza número 1 y ve colocando las otras.

10**D** **Puzzeln nach Bild****GB USA** **Puzzle by the picture****F** **Assemble les pièces à l'aide de l'image****I** **Componi seguendo l'immagine****NL** **Puzzelen volgens voorbeeld****E** **Montar el puzzle siguiendo la imagen****11**

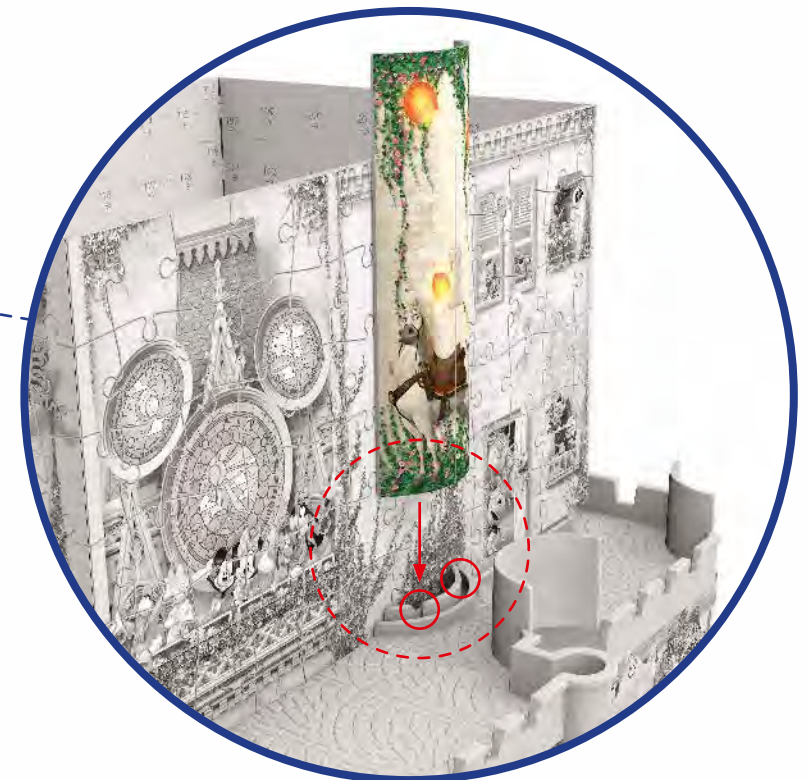
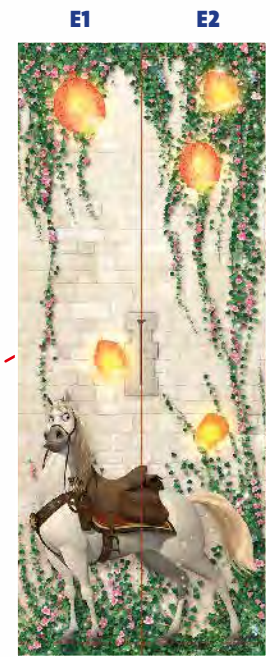
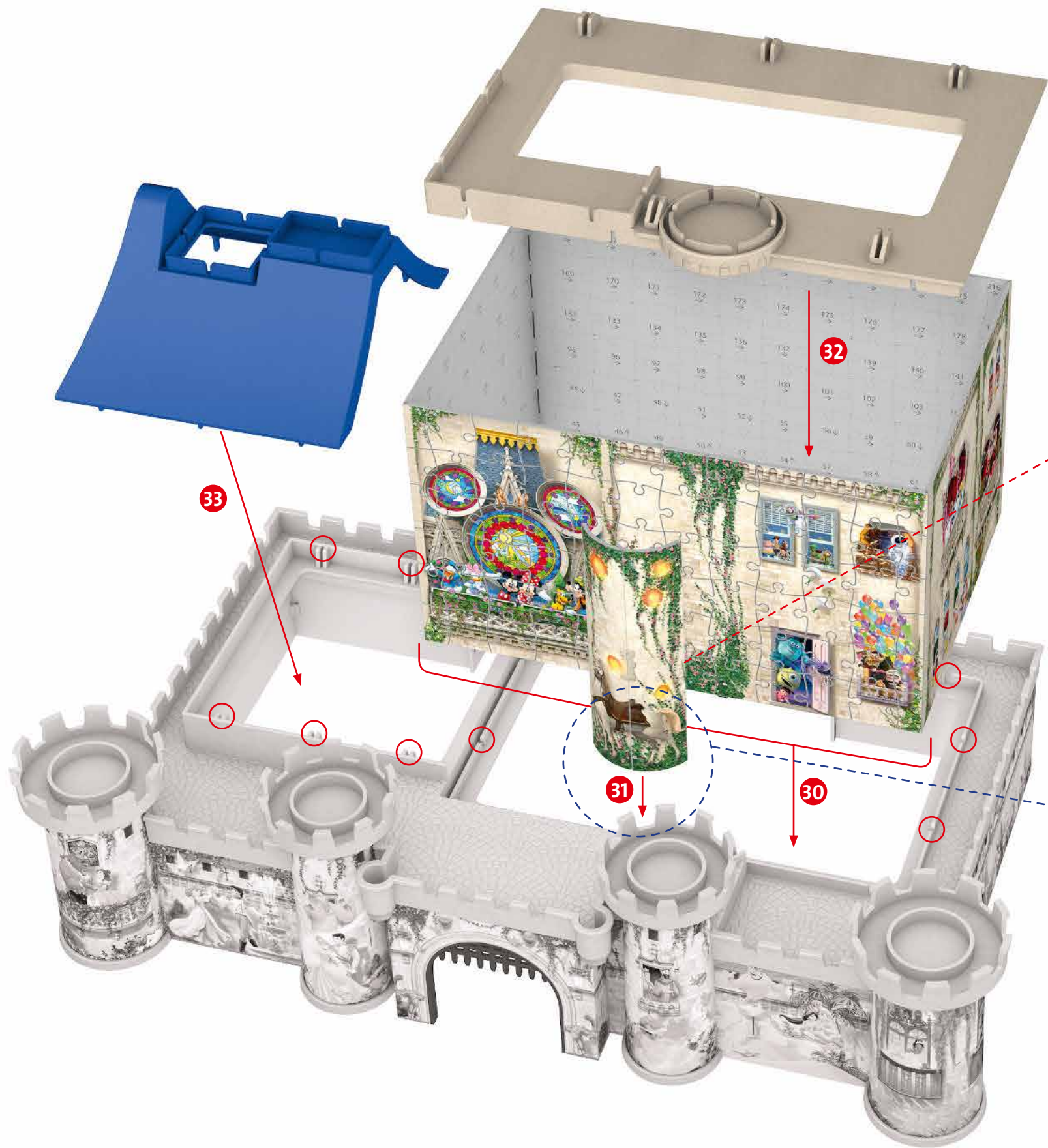

F

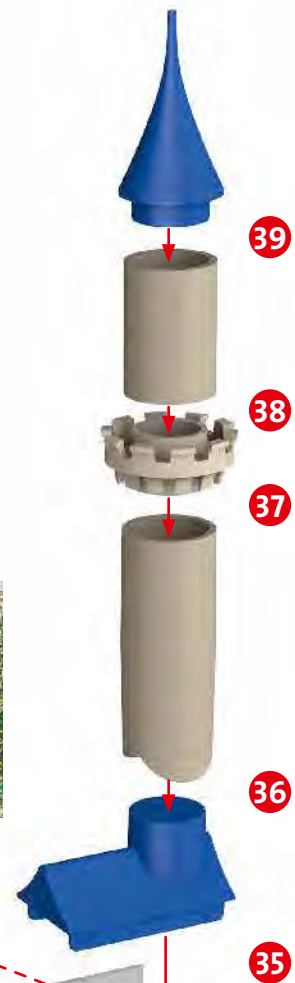
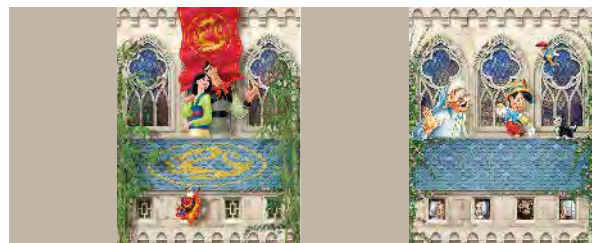

34

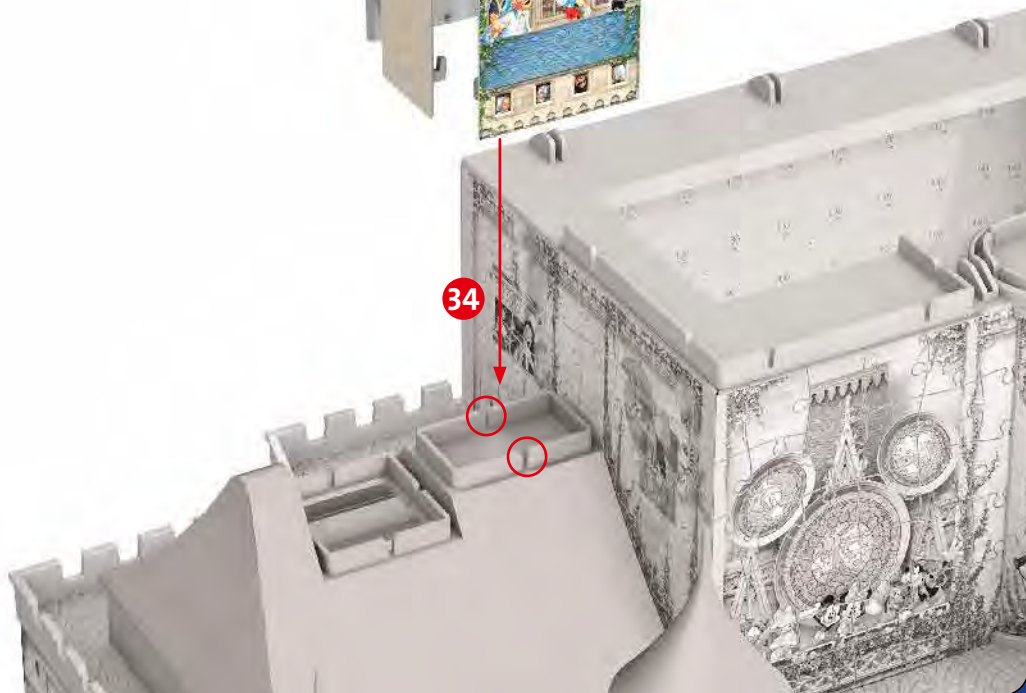

14

G



40

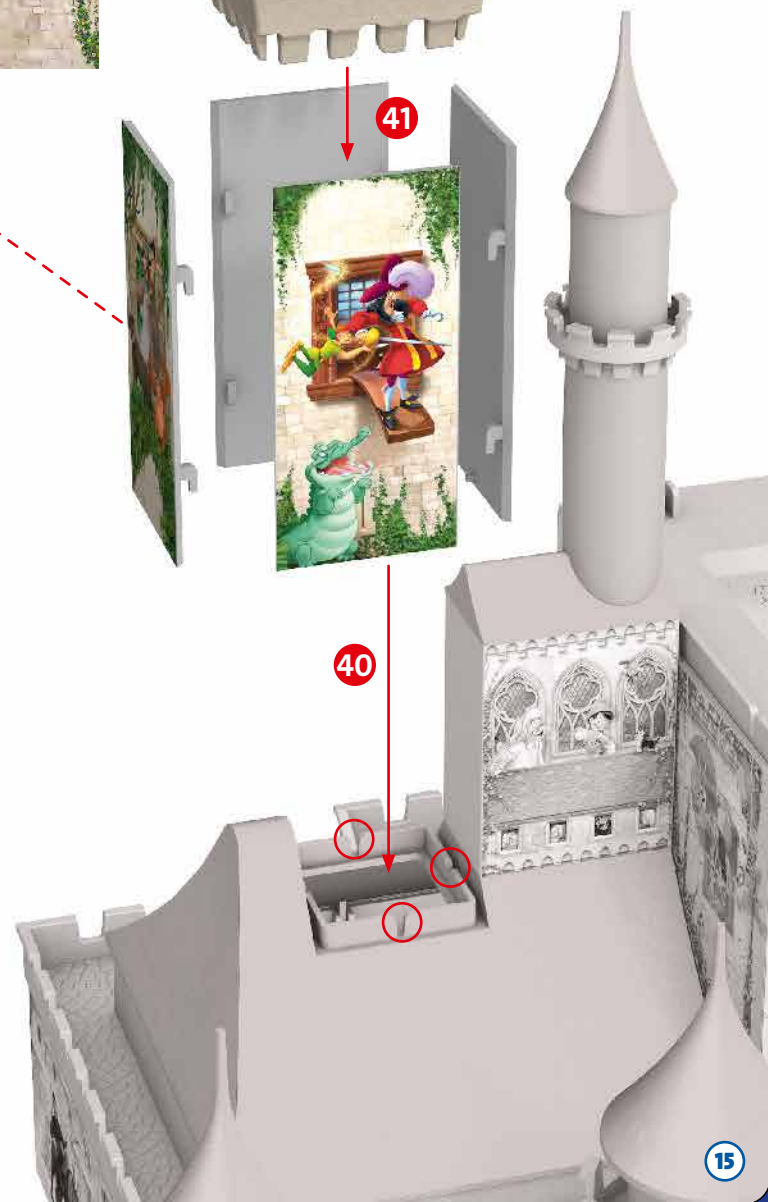

15

H

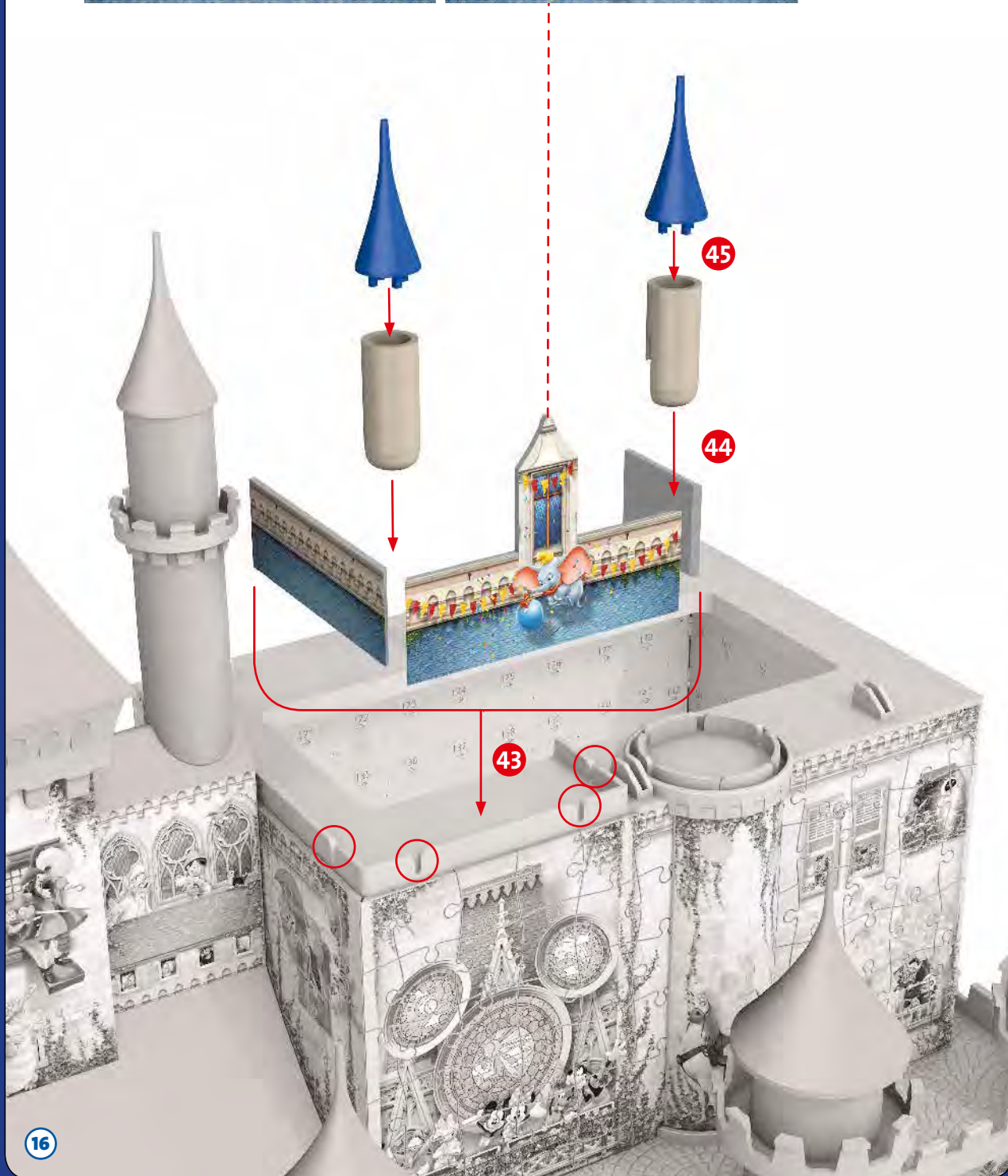
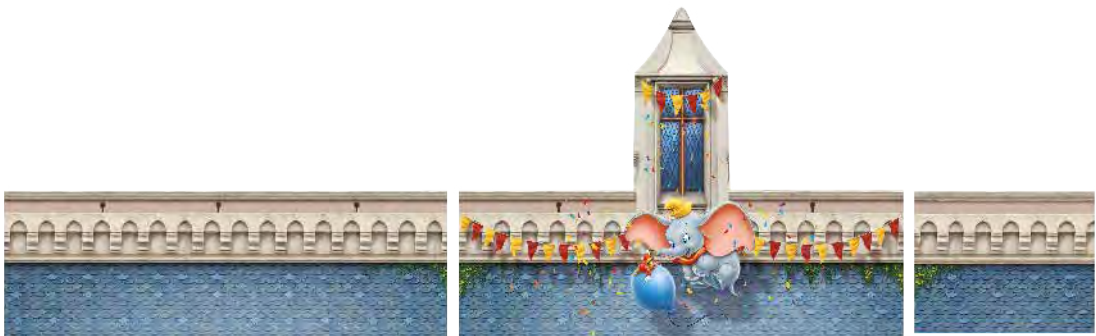

16

I

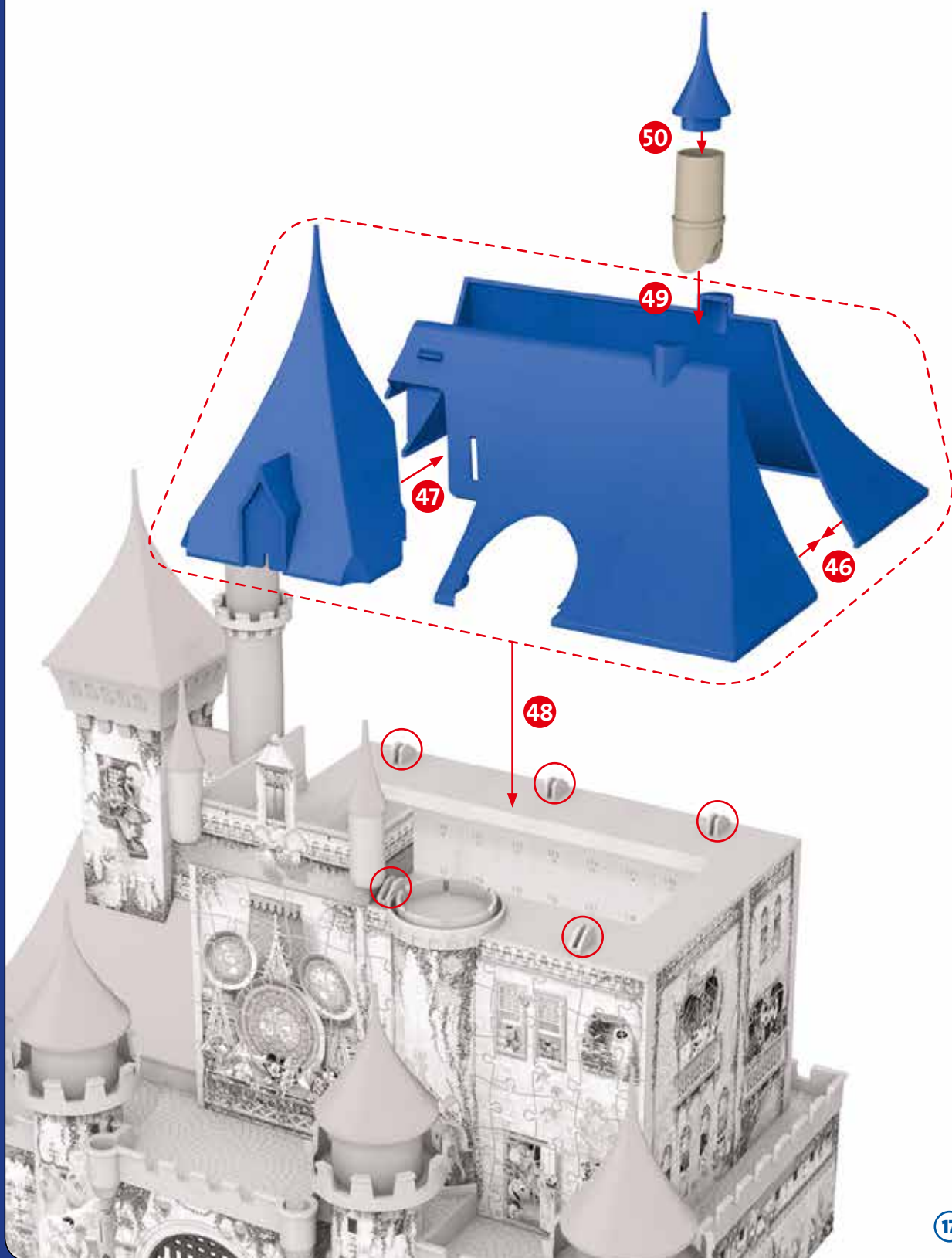

17

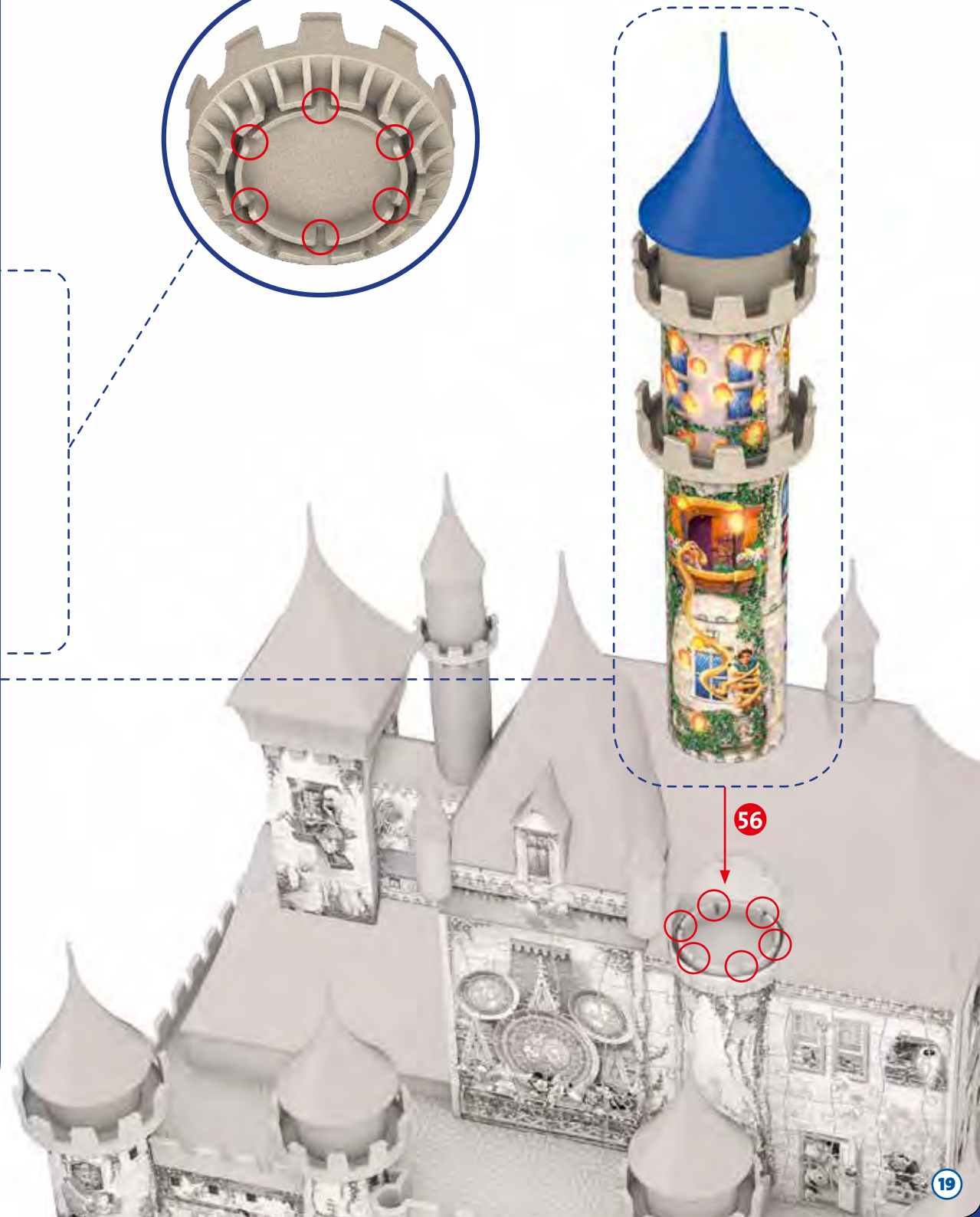
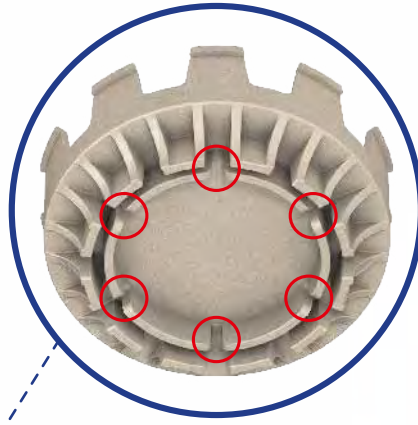
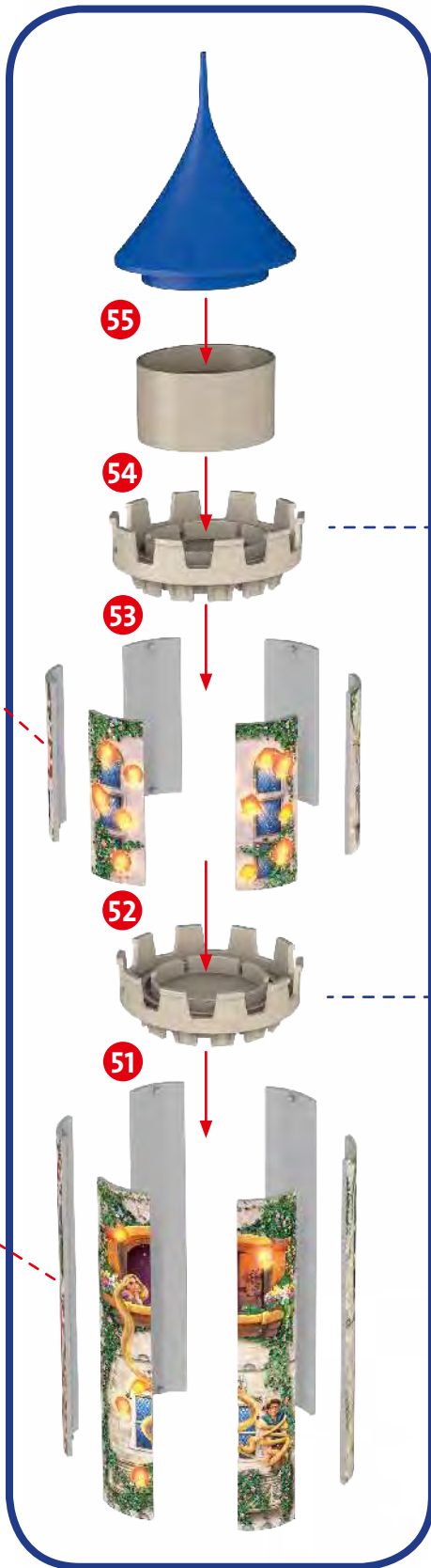
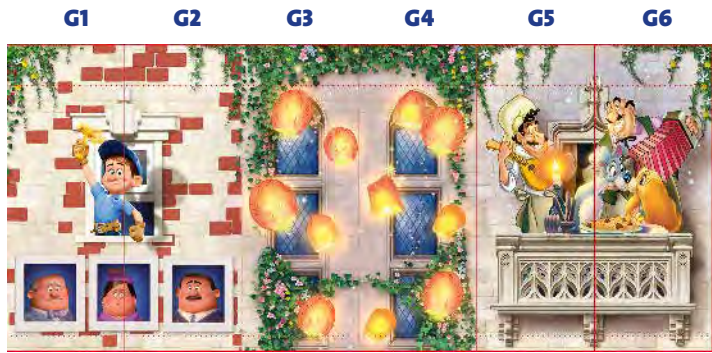



- (D) Verpackung aufbewahren, da sie wichtige Informationen enthält! (F) Garder l'emballage vu qu'il contient des informations importantes!
 (I) Conservare la confezione perché essa contiene informazioni importanti! (E) ¡Guardar el embalaje porque contiene información importante!
 (GB) Retain packaging: contains important information! (NL) Bewaar de verpakking omdat hierop belangrijke informatie is vermeld!
 (P) Guardar a embalagem, contém informações importantes! (BG) Запазете опаковката, защото тя съдържа важна информация!
 (CZ) Obal uschovejte, obsahuje důležité informace! (DK) Opbevar emballagen, fordi den indeholder vigtige oplysninger! (EST) Hoidke pakend alles, pakendilt leiaste olulist teavet! (FIN) Säilytä pakkaus, sillä siinä on tärkeää tietoa! (GR) Διατηρείστε τη συσκευασία για μελλοντική αναφορά!
 (HR) Sačuvajte pakovanje zato što sadrži važne informacije! (H) A csomagolást őrizze meg, mert fontos információkat tartalmaz! (LT) Saugokite pakuotę, joje yra svarbios informacijos! (LV) Iepakojumu uzglabāt, jo tas satur svarīgu informāciju! (MNE) Sačuvajte ambalažu pošto sadrži važne informacije!
 (N) Oppbevar emballasjen da den inneholder viktig informasjon! (PL) Zachować opakowanie, gdyż zawiera ono ważne informacje! (RO) Vă rugăm să păstrați ambalajul, deoarece conține informații importante! (SRB) Sačuvajte ambalažu pošto sadrži važne informacije!
 (S) Spara förpackningen eftersom den innehåller viktig information! (SLO) Shranite embalažo, ker vsebuje pomembne informacije!
 (SK) Balenie skladujte, pretože obsahuje dôležité informácie! (TR) Ambalajı muhafaza edin, önemli bilgiler içerir! (UA) Упаковку зберігайте, оскільки на ній вказана важлива інформація!